

Installation Instructions & User Guide

RFE PLUS
Thermal Radiators

RF4E Plus | RF6E Plus | RF8E Plus | RF10E Plus | RF12E Plus | RF14E Plus



Please read these instructions carefully before installing or using this appliance for the first time.

ELNUR powered by
Gabarrón

1. IMPORTANT INFORMATION

- The warranty of the heater will not cover any damage caused by non-observance of any of these instructions.
- The instructions should be retained for future reference. This guide must be kept and given to any new owner.
- This appliance can be used by children aged from 8 years and above and persons with reduced physical, sensory or mental capabilities or lack of experience and knowledge if they have been given supervision or instruction concerning the use of the appliance in a safe way and understand the hazards involved. Children must not play with the appliance. Cleaning and user maintenance must not be made by children without supervision.
- Children aged from 3 years and less than 8 years shall only switch on/off the appliance provided that it has been placed or installed in its intended normal operating position and they have been given supervision or instruction concerning use of the appliance in a safe way and understand the hazards involved. Children aged from 3 years and less than 8 years shall not plug in, regulate and clean the appliance or perform user maintenance.
- Children of less than 3 years should be kept away unless continuously supervised.
- Please check that the voltage in the rating label fits the power supply.
- The use of these heaters is forbidden in any area where there is a presence of gases, explosives or inflammable objects.
- Do not use this heater to dry clothes. Do not cover this heater or put objects in contact with it.
- Neither the connecting cable nor any other object must come into contact with the hot unit.
- Do not cover this heater at any time.
- The air outlet at the top of the thermal radiator and the air inlet at the bottom are provided to ensure the most efficient operation of the appliance. They also protect the heater from overheating; therefore, it is essential that at no time are they covered.
- This heater should be switched off at the isolating switch before any repair work is carried out.
- The installation must be carried out in accordance with the current electrical regulations.
- Should the heater be moved and reinstalled it is essential that the work is carried out by a fully qualified technician.
- The heater should not be installed just below an electrical socket.
- The appliance must be installed in such a way that it is impossible for anyone using a bath or shower, to touch the controls.
- The heater is fitted with a flexible cable size 3 x 1mm² for electrical connection. It may be used to connect the heater to the fixed wiring of the premises through a suitable connection box positioned adjacent to the heater.
- The supply circuit to the heater must incorporate a double pole isolating switch having a contact separation of at least 3 mm.
- If the flexible power cable for this unit is damaged, it may only be replaced by a repair workshop recognised by the manufacturer, as special tools are necessary.
- This appliance must be earthed.
- All models are supplied with an electrical interrupt cut-out. This will switch off the heater if, for any reason, it overheats. Should the cut-out operate, turn the heater off and remove the cause for the overheating. The cut-out will be reset automatically.
- This heater is filled with a precise quantity of special oil. Repairs requiring opening of the oil container are only to be made by the manufacturer or their service agent who should be contacted if there is an oil leakage.
- Regulations concerning the disposal of oil when scrapping the appliance have to be followed.
- The presence of air particles of smoke, dust and other pollutants could, in time, discolour the walls and surfaces around the heater.
- CAUTION – Some parts of this product can become very hot and cause burns. Particular attention must be given when children and vulnerable people are present.



WARNING: Please read these instructions before installing or using this appliance for the first time.

2: INSTALLATION INSTRUCTIONS

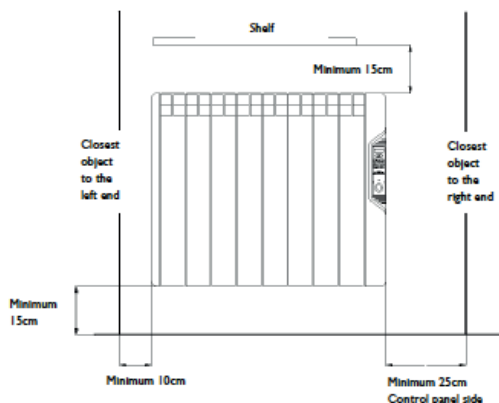

- Open the package and check that it is the correct model and it is in good condition.
- To obtain optimum performances it is necessary to maintain a minimum clearance of 15 cm between the radiator and any flammable material such as furniture, curtains etc.
- The rest of clearances required to maintain are indicated on the figure opposite:

Position and fix the brackets at the correct distance from the floor. It is possible to use the radiator as a measuring unit by positioning it on the polystyrene packaging and placing two supports above as indicated on the figure (shown right).

- The studs and screws to attach the supports are in the accessories bag.
- Hang the unit on the hooks of the brackets.
- By turning the screws, the metallic square will go downwards, retaining the heater. Repeat this on the other bracket.

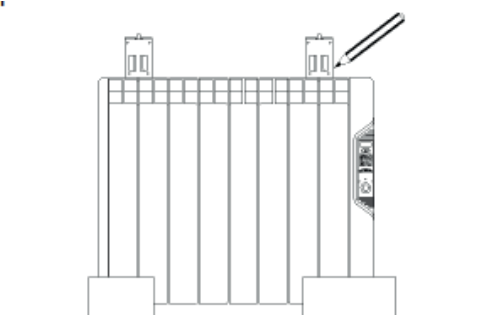

3. USING THE THERMAL RADIATOR

Key "+":
It increases the values.

SUN indicator

SUN key:
Press once to see the SUN temperature value.
Press + or - keys to modify the value.

MOON key:
Press once to see the MOON temperature value.
Press + or - keys to modify the value.

Moon indicator

Key "-":
It decreases the values.

Digital DISPLAY:
It shows the time, temperature and other messages

Heating indicator:
This small dot will be lit when the heater is consuming energy.

Frost protection key:
If the display shows the time the heater is in frost protection mode. Press this key to shift from frost protection mode to standard mode and vice versa.

Press this key for more than two seconds to set the time or day of the week.

PRG key:
Allows you to create check or modify programs.
Move forward with + or - keys and allocate the SUN, MOON, or ❄ temperature to any of the 48 intervals of 30 minutes of the day by means of the relevant key.

Selector:



- O The heater is switched off permanently.
- P The heater is following a program.
- I The heater is maintaining the SUN temperature constantly.

Both indicators will be lit at the same time

RFE Plus models have a built in electronic thermostat with a sensibility of 0.1 °C. It is possible to set temperatures with an accuracy of 0.5°C.

The daily or weekly programmer (selectable) allows you to allocate three different temperature levels to any of the 48 intervals of 30 minutes of the day.

SWITCHING ON THE HEATER AND SETTING THE TIME

Turn the mode selector dial to P position then press and hold the  until the time flashes intermittently. Set the hours by pressing the + and - keys. Set the minutes the same way. Press the  key once more to store the time.

If at any point you should need to change the times that have been set, just press the  key and repeat the above process.

FROST PROTECTION MODE

With this mode on, if the room temperature drops below 30C the heater will connect itself automatically.

If the display shows the time, the heater is in frost protection mode. Press the  key to shift from frost protection mode (time is shown in the display) to standard mode (temperature is shown in the display) and vice versa.

SELECTOR "O", "P", "I".

Position "O":

The heater is switched off permanently. The display is switched off.

Position "P":

The heater is following a program. It will maintain the SUN, MOON or  temperatures as per the introduced program. At this position if the display shows the time the heater is in frost protection mode.

Position "I":



The heater is maintaining the SUN temperature and will be identified by both the SUN and MOON indicator being lit. This is useful when the SUN temperature is required, and we do not want to modify the program. At this position, if the display shows the time the heater is in frost protection mode. Press the  key to shift from frost protection mode (time is shown in the display) to standard mode (temperature is shown in the display) and vice versa.

SUN, MOON AND TEMPERATURES

The electronic programmer is able to handle three temperature levels during a 24hr period.

Press the  key to set the SUN temperature.

The display will show the SUN temperature. The display will show the SUN temperature value blinking.

Set the SUN temperature value by means of the + and - keys and press the  key to store the value. If the display shows the time the heater is in frost protection mode. Press the  key to shift from frost protection mode (time is shown in the display) to standard mode (temperature is shown in the display) and vice versa.

Repeat the above steps with the  key to set the MOON temperature.

The  temperature level is 30C and it is a fixed value.



SUN, MOON or  temperatures can be allocated to any of the 48 intervals of 30 minutes throughout the day.

DAILY PROGRAMMES



It is best to visualise the day split in to 48 intervals of 30 minutes each. The SUN, MOON or  temperatures can be allocated to any of them.

The default settings include a daily mode so that the heater will repeat the program every day. If different programmes are required throughout the week, please see the next step WEEKLY PROGRAMMES. To check a programme or to make a new one, follow these steps:

Press the 'PRG' key and the display will show 00:00 intermittently.

Press one of the three keys -    to allocate SUN, MOON or OFF (frost protection) from 00:00h to 00:30h. If SUN or MOON temperatures are selected the relevant luminous indicator will be lit.

If OFF temperature  is selected both luminous indicators will be off.

Press the + key to go to the next interval. The display will show **00:30** intermittently and, again, press one of the three keys    to allocate SUN, MOON or OFF (frost protection) from 00:30h to 01:00h or press + key directly if the existing temperature level is ok.

Repeat these steps allocating the desired temperatures levels over the 24 hours of the day. Press the - key at any time to modify a previous period. By reaching the **23:30** in the display and pressing + key, the controller will store the program and will return to the previous mode.

At any time **PRG** key can be used also to store the program and return the previous mode.

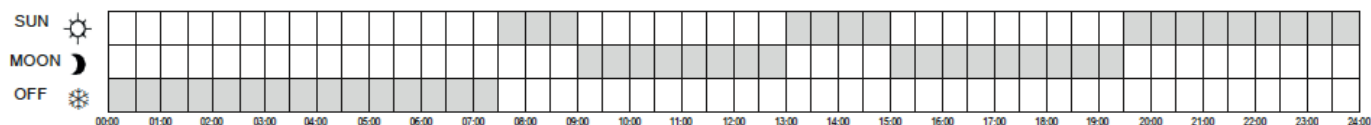

EXAMPLE

Let's see an example of how to introduce a program with the above distribution of temperatures.

OFF from 24:00h to 7:30h in the morning. The heater will be on only if the temperature drops to 3°C.

SUN temperature from 7:30h to 9:00h.

MOON temperature from 9:00h to 13:00h.

SUN temperature from 13:00h to 15:00h.

MOON temperature from 15:00h to 19:30h.

SUN temperature from 19:30h to 24:00h.

1 - Press **PRG**

2 - Press 

3 - Press **+** key

4 - Repeat steps 2 and 3 until display shows:

5 - Press 

6 - Press **+** key

7 - Press 

8 - Press **+** key

9 - Press 

10 - Press **+** key

11 - Press 

12 - Press **+** key

13 - Repeat steps 11 and 12 until display shows:

14 - Press 

15 - Press **+** key

16 - Repeat steps 14 and 15 until display shows:

17 - Press 

18 - Press **+** key

19 - Repeat steps 17 and 18 until display shows:





















20 - Press 

21 - Press **+** key

22 - Repeat steps 20 and 21 until display shows:



23 - Press 

24 - Press **+** key



00:00
  Off
 
00:30
07:30
  On
08:00
 
08:30
 
09:00
 
09:30
13:00
 
13:30
15:00
 
15:30
19:30
 
20:00
23:30
 
GRAB

WEEKLY PROGRAMMES

It is possible to allocate different programmes to different days of the week. To do this, the controller has to be changed from 24hr mode (factory default) to 24hr/7days mode as follows:

Move the selector to **O** position, the display will be Off. Press the  key and at the same time turn the selector to **P** position maintaining hold of the  key for five seconds. The display will show **P-SE** which means that weekly mode has been set.

SETTING THE DAY:

Press and hold the  key until the display shows the number of the day. Set the correct number, if required, by pressing the + or - keys. Press the  key again and the values will be saved.



To check a programme or to make a new one press **PRG** key. The display will show **day1**. Press the **PRG** key again and the display will show **00:00** intermittently. Follow the steps from the DAILY PROGRAMMES section until the display shows **day1** again. Repeat this process with the 7 days of the week. When the display shows **day7** the weekly program will be stored by pressing + key.

If the display shows **day1 then pressing and holding the + key will copy the day 1 program to day 2 and so on.**

It is possible to allocate any of the three temperature levels to all of the intervals on any of the days by holding the relevant (temperature mode) key until an audible signal is heard.

To turn back the controller from 24hr/7days to a single 24hr period press the **PRG** key for six seconds. This will restore the factory default settings.

KEYBOARD LOCK

Press and hold the  key until the following is shown on the display **[C--]** The heater will still function internally. To unlock the keyboard press and hold the  key.

SUN MANUAL OVERRIDE

In programming mode, the heater will maintain the sun temperature set point and will ignore the pre-set programme until the next change in the programming temperature level.

Hold the SUN key pressed in programming mode to set the sun manual override. Both SUN and MOON indicators will be lit to confirm this.

This function could be useful when SUN temperature is required and we do not want to modify the program.

By pressing the SUN key for 4 seconds with Sun Manual Override activated, the function will be removed and the heater will follow the programme again.

4: ADVANCED FUNCTION

OPEN WINDOW DETECTION

With open window detection activated, the heating element will be disconnected automatically when a sharp decrease in temperature in the room is detected avoiding energy wastage. After this period of time, the radiator returns to the prior operation mode.

When Open Window Detection is working, the word Open will be displayed alternating with the status of the current mode.

Note: To activate the open window detection please refer to ADVANCED FUNCTION ACTIVATION section.

ADAPTIVE START CONTROL

RFE Plus electronic control analyses the heating requirements of the room where the radiator is installed using this information to turn on the heating element in advance in order to reach the set point temperature at the desired time.

When Adaptive Start Control is working, the word AdAP will be displayed alternating with the status of the current mode.

Note: To activate the adaptive start control please refer to ADVANCED FUNCTION ACTIVATION section.

ADVANCED FUNCTION ACTIVATION

Advanced functions Open Windows Detection and Adaptive Start Control are disabled by default. To enable / disable these functions, the following steps must be followed:

Move the selector to **O** position, the display will be Off. Press the * key and at the same time turn the selector to **P** position maintaining the * key at least five seconds.

The display will show **OPEn** alternating with the status of the function (On or OFF). Use the navigation keys + or - to enable / disable Open Windows Detection function.

Confirm the new value for the function by pressing the **PRG** key. The next function (AdAP) is shown alternating with its status (On or OFF). Use the navigation keys + or - to enable / disable Adaptive Start Control function. Confirm the new value for the function by pressing the **PRG** key.

5: UNIT RESET

The heater reset establishes the factory configuration of the heater removing the programming, establishing the daily programming and disabling the advanced functions. To reset the unit, hold the **PRG** key for 4 seconds, the display will show **InIC** to indicate the heater has been reset.

6: CLEANING AND MAINTENANCE

The radiators do not require any special maintenance providing thermal comfort during large periods. Clean dust with a dry, soft cloth only when the unit is disconnected and cold.

Do not use solvents or abrasive products for cleaning.

This thermal radiator has been manufactured under an assured quality system using environment friendly processes.

Please take the heaters to a clean point once their useful life is finished, in order to recycle their materials in the right way.

7. TROUBLESHOOTING

The thermal radiator does not heat.	Check the heater or the air inlets are not covered. If the display shows the time, press the * key to switch on the heater. Check that the DAY or NIGHT temperatures are right.
The room does not reach the required temperature.	Check the selected temperature is in accordance with the desired temperature. Maybe the room needs more heating power.
DAY and NIGHT luminous indicators are lit at the same time	Continuous mode has been selected. If the knob is in the "I" Position, turn it to the "P" position to return to the program mode if required. If the knob is in the "P" Position, hold the Sun key for 4 seconds to return to the programming.
The display shows "Err1" or "Err2"	Contact the after sales service.
Only daily programmes	The controller is in single 24hr mode (factory default). See WEEKLY PROGRAMMES section to switch to 24hr/7days mode.
The keyboard does not respond.	If the display shows  , the keyboard is locked. To unlock it, press the * key more than six seconds.

8. SPECIFICATIONS

Models	RF4E Plus	RF6E Plus	RF8E Plus	RF10E Plus	RF12E Plus	RF14E Plus
Elements	4	6	8	10	12	14
Length (cm)	41.5	57.5	73.5	89.5	105.5	121.5
Width (cm)	10 cm plus 2 cm clearance					
Height (cm)	58					
Weight (kg)	9.5	13	17	20	23.5	27
Voltage	220 - 240 -					
Isolation	Class I					
Power (W)	500	750	1000	1250	1500	2000

9. MAIN COMPONENTS LIST

Right side plastic case	ref. 30100900	500 W Heating Element	ref. 30100142
Left side plastic case	ref. 30100910	750 W Heating Element	ref. 30100152
Main PCB	ref. 30100084	1000 W Heating Element	ref. 30100162
Rotary switch	ref. 30100015	1250 W Heating Element	ref. 30100172
Keyboard	ref. 30100095	1500 W Heating Element	ref. 30100182
85°C thermal limiter	ref. 3010004077	2000 W Heating Element	ref. 30100202

10. WIRING

R heating element

Ts safety cut out

C three way selector

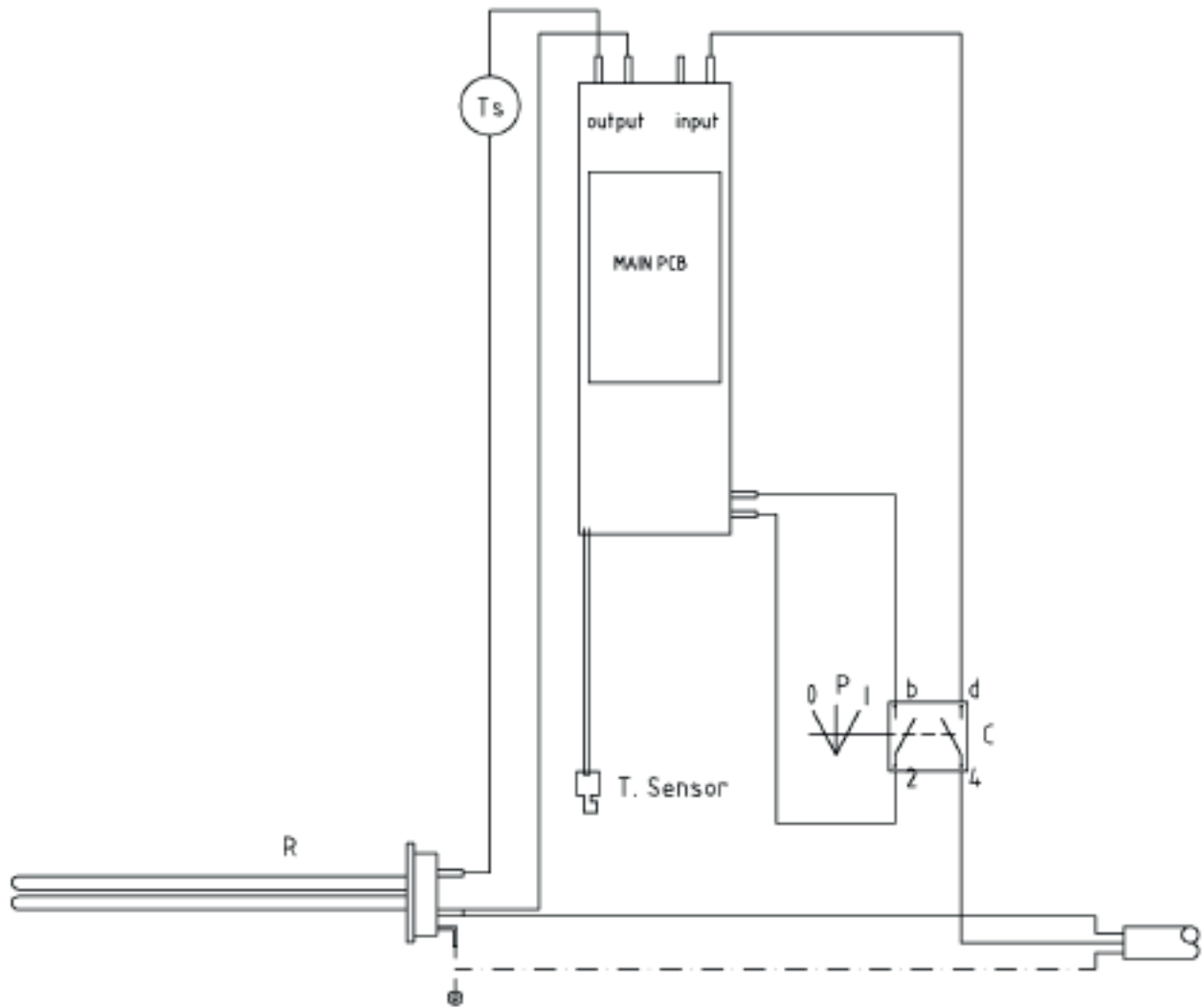

PRODUCT FICHE

MODEL(S): GABARRON RF4E Plus, RF6E Plus, RF8E Plus, RF10E Plus, RF12E Plus, RF14E Plus

ErP

Item	Symbol	Value						Unit
		RF4E PLUS	RF6E PLUS	RF8E PLUS	RF10E PLUS	RF12E PLUS	RF14E PLUS	
Heat Output								
Nominal heat output	P _{nom}	0.5	0.75	1.0	1.25	1.5	2.0	kW
Minimum heat output	P _{min}	N.A.	N.A.	N.A.	N.A.	N.A.	N.A.	kW
Maximum continuous heat output	P _{max, c}	0.5	0.75	1.0	1.25	1.5	2.0	kW
Auxiliary electricity consumption								
At nominal heat output	el _{max}	0.000	0.000	0.000	0.000	0.000	0.000	kW
At minimum heat output	el _{min}	0.000	0.000	0.000	0.000	0.000	0.000	kW
In standby mode	el _{sb}	<0.0005	<0.0005	<0.0005	<0.0005	<0.0005	<0.0005	kW

Item	Value. All models
Type of heat output / room temperature control	
Electronic room temperature control plus week timer	Yes
Other control options	
Room temperature control, with open window detection	Yes
With distance control option	No
With adaptive start control	Yes

Contact details	ELNUR, UK Unit 1, Brown Street North, Leigh, Lancashire, WN7 1BU
------------------------	---

Commission Regulation (UE) 2015/1188 of 28 April 2015. Ecodesign requirements for electric storage local space heaters.

ELNUR

Supplier:

ELNUR UK Ltd.
Unit 1, Brown Street North
Leigh, Lancashire, WN7 1BU.
+44(0)1942 670119
info@elnur.co.uk

Manufactured by:

ELNUR S.A.
Travesía de Villa Esther, 11 28110, Algete
Madrid Telephone: +34 916281440



The symbol on the product or in its packaging indicates that this product may not be treated as household waste. Instead it shall be handed over to the applicable collection point for the recycling of electrical and electronic equipment. By ensuring this product is disposed of correctly, you will help prevent potential negative consequences for the environment and human health, which could otherwise be caused by inappropriate waste handling of this product. For more detailed information about recycling of this product, please contact your local council office, your household waste disposal service or the shop where you purchased the product. These instructions are only valid in the EU member states.

15190020 R2 | EN

www.elnur.co.uk



© All rights reserved. As part of the continuous improvement policy, ELNUR, S.A. reserves the right to alter or modify any specifications without notice.