

# Installation Instructions

**TBB-K  
Towel Rails**

---

TBB-8K | TBB-12K | TBC-8K | TBC-12K

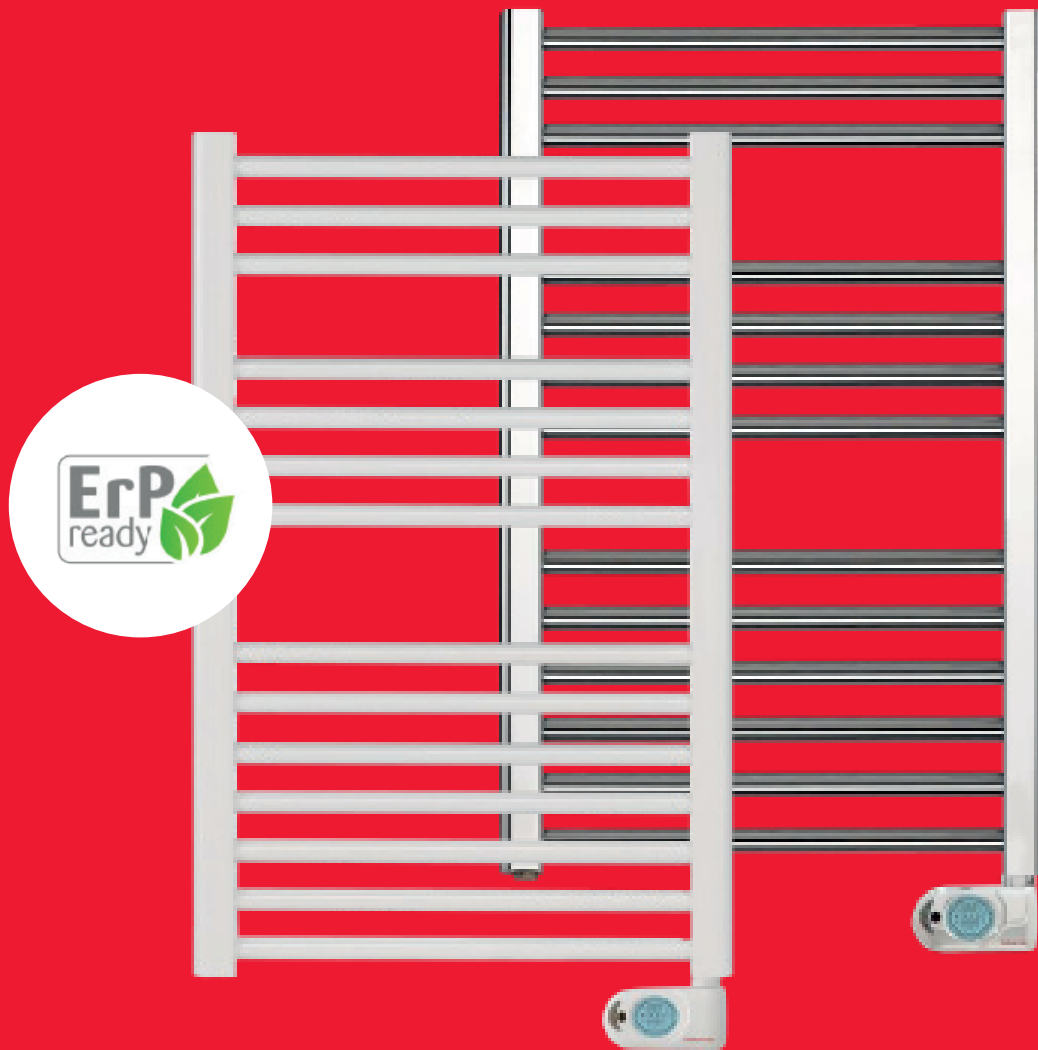

Please read these instructions carefully before installing or using this appliance for the first time.

**ELNUR** powered by  
**Gabarrón**

# 1. WARNING

- The warranty of the towel rail will not cover any damage caused by the non observance of any of these instructions. Please read these instructions before installing or using this appliance for the first time. This guide must be kept and given to any new user.
- This appliance can be used by children aged from 8 years and above and persons with reduced physical, sensory or mental capabilities or lack of experience and knowledge if they have been given supervision or instruction concerning the use of the appliance in a safe way and understand the hazards involved. Children must not play with the appliance. Cleaning and user maintenance must not be made by children without supervision.
- Children aged from 3 years and less than 8 years shall only switch on/off the appliance provided that it has been placed or installed in its intended normal operating position and they have been given supervision or instruction concerning use of the appliance in a safe way and understand the hazards involved. Children aged from 3 years and less than 8 years shall not plug in, regulate and clean the appliance or perform user maintenance.
- Children of less than 3 years should be kept away unless continuously supervised.
- Please, check that the voltage in the rating label fits the power supply.
- The surfaces of the towel rail can be hot and caution is advised when small children are near the appliance. **WARNING:** In order to avoid a hazard for very young children, this appliance should be installed so that the lowest heated rail is at least 600 mm above the ground.
- Before carrying out any work inside the appliance, the towel rail must be disconnected from the electricity supply.
- The use of electric towel rails is forbidden in any area where there is a presence of gases, explosives or inflammable objects.
- The towel rail should not be installed exactly under an electric outlet.
- The appliance must be installed in such a way that it is impossible for anyone using a bath or shower, to touch the controls.
- The towel rail is fitted with a flexible cable size 3 x 1.00 mm<sup>2</sup> for electrical connection. It may be used to connect the heater to the fixed wiring of the premises through a suitable connection box positioned adjacent to the heater.
- The supply circuit to the towel rail must incorporate a double pole isolating switch having a contact separation of at least 3 mm.
- The installation must be carried out in accordance with the current electrical regulations. Should the towel rail be moved and reinstalled it is essential that the work is carried out by a fully qualified technician.
- The supply lead must not contact the surface of the towel rail.

- If the supply lead of the towel rail is damaged it must be replaced by service personnel authorized by the manufacturer, since special tools are needed.
- This towel rail is filled with a precise quantity of thermal fluid. Repairs requiring opening of the fluid container are only to be made by the manufacturer or his service agent who should be contacted if there is a fluid leakage.
- Regulations concerning the disposal of fluid when scrapping the appliance have to be followed.
- The presence of air particles of smoke, dust and other pollutants could, in time, discolour the walls and surfaces around the towel rail.
- All the models incorporate a safety device. This will disconnect the towel rail if for some reason it fails. If the safety device activates the towel rail will need to be repaired by service personnel authorized by the manufacturer.

# 2. INSTRUCTIONS FOR INSTALLATION

The towel rail is designed to only work in a vertical position and fixed to the wall, never to the ceiling.

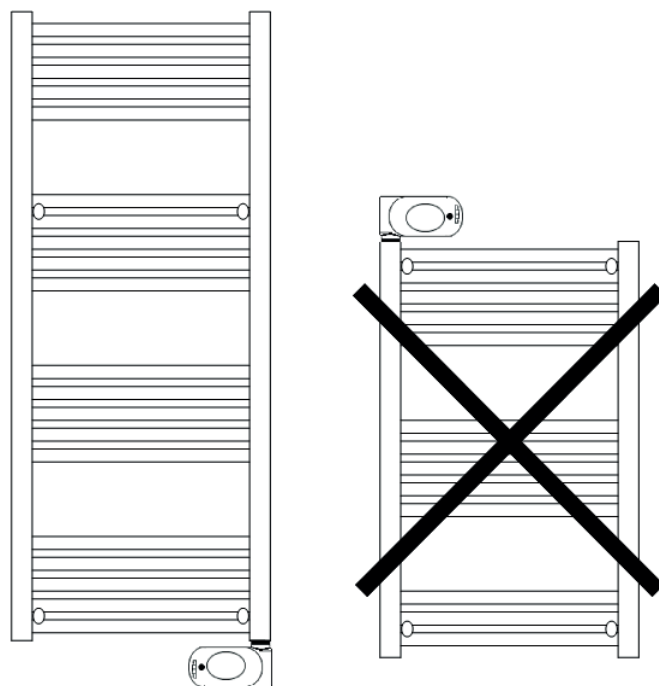

The fixation to the wall is carried out by means of the supports given with the appliance, according to the following outline.

A clear distance of 5 cm must be allowed around the towel rail.

Cable exit always on the lower right side.

Connect the wires to a fix wall socket or to an appropriate plug WITHOUT EARTH. Connect the black wire to the signal wire when available. Do not connect this wire to any EARTH lead.

The towel rail supports should be placed in sequence as indicated below:

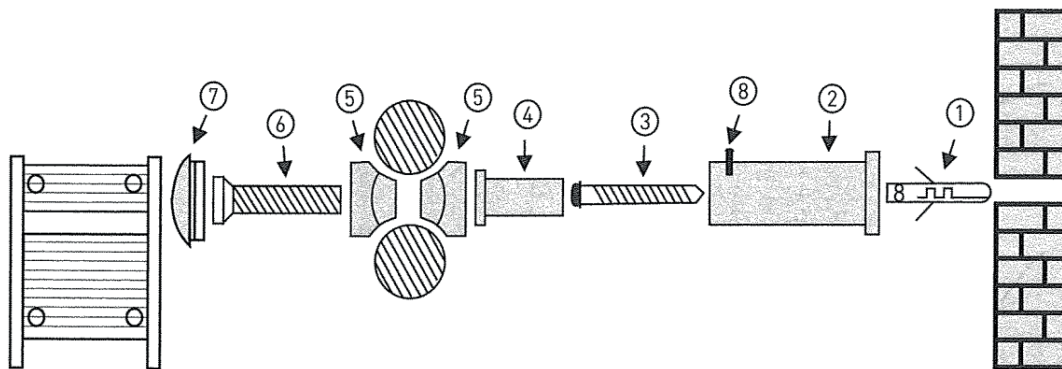

### 3. APPLICATION OF USE

**IR Receiver:** Allows full remote control of the device through the dedicated remote control.

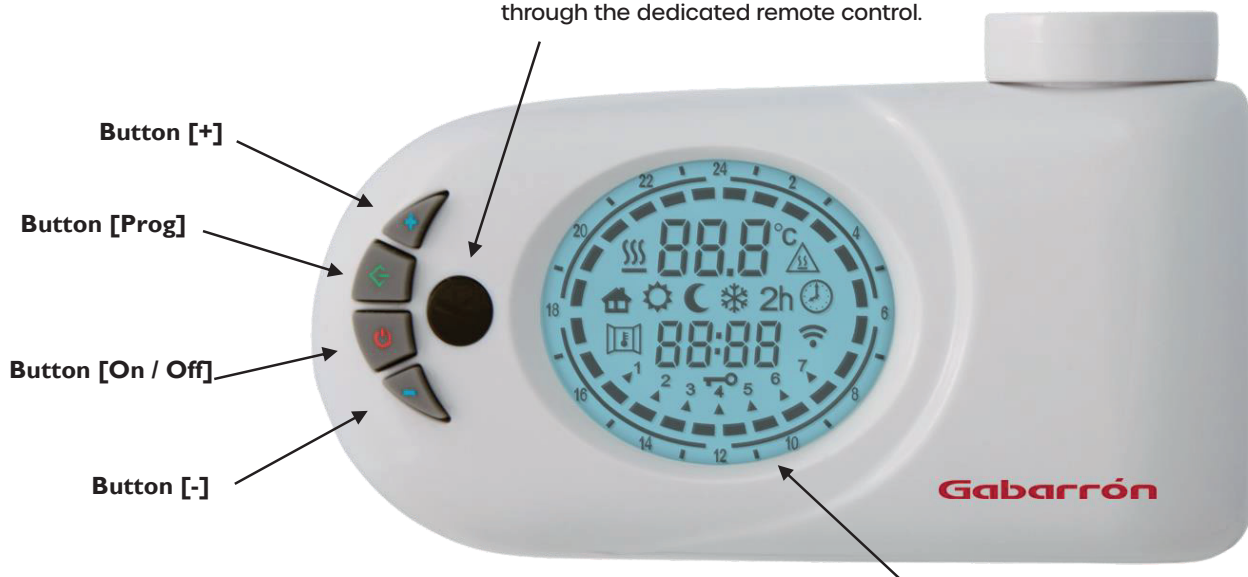

**Backlit Display:** Displays all device related information.

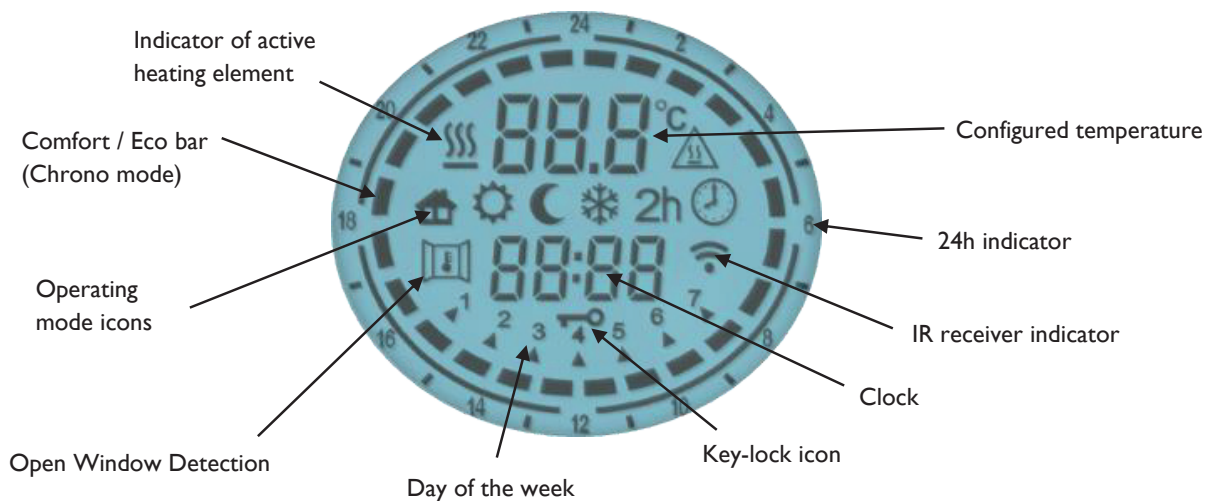

**Note 1:** When the symbol  is on, the heating element is active.

**Note 2:** This icon  indicates that is being received signal from remote control. (optional).

## POWER ON / STAND-BY

Press the [On/Stand-by] key to turn on the device or to enter the "Stand-by" mode.

When activated, the bottom part of the display shows the current time, while the configured operative mode and the temperature are shown in the upper part, when in "Stand-by" mode current time, day of the week and the message "Stb" are displayed.

**Note:** When the device goes into "Stand-by" mode it beeps twice for 0.5s. When the device is activated it beeps once for 1s.

## COMFORT & ECO TEMPERATURES

Two different levels of temperature can be set:

- **Comfort:** Temperature level used for Chrono, Pilot Wire and Comfort modes. It is recommended for the periods of time when the user is at home and the maximum comfort is required.
- **Eco:** Temperature level used for Chrono and Eco modes. It is recommended for nights and small away periods of time.

Set the mode of the temperature level to modify (Comfort or Eco) using the button [Prog] and modify its value for each level. The desired temperature can be set pressing the [+] and [-] buttons. (From 7°C to 32°C).

**Note:** The temperature of "Eco" mode must be below to the "Comfort" mode temperature. For this reason, the

"Eco" mode temperature can be set to a value between 7°C and the configured "Comfort" mode temperature and the "Comfort" mode temperature can be set to a value between the configured "Eco" mode temperature and 32°C.

## OPERATING MODES

Press the [Prog] button to select the desired operative mode. An icon on the display indicates the selected operating mode, according to the following table:

					
Pilot Wire	Comfort	Eco	Frost Prot.	Timer-2h	Chrono

## COMFORT MODE

The "Comfort" mode maintains the room temperature to the selected value. To set this operative mode:

- Press the [Prog] button until the display shows the "Comfort" icon.
- Set the desired temperature trough [+] and [-] buttons and wait until the displayed temperature stops blinking.

## ECO MODE

The "Eco" mode sets a value of temperature below the "Comfort" temperature value. It is suggested to set this operating mode during the night or when the room is not occupied for 2 or more hours.

- Press the [Prog] button until the display shows the "Eco" icon.
- Set the desired temperature using the [+] and [-] buttons and wait until the displayed temperature stops blinking.

## FROST PROTECTION MODE

In "Frost Protection" mode, the temperature is fixed to 7°C. The device activates the heating element when the room temperature falls below 7°C. It is suggested to set this operating mode when the room is not occupied for several days.

- Press the [Prog] button until the display shows the "Frost Protection" icon.

## 2H-TIMER MODE

The "Timer 2h" mode can be used to quickly warm up the room or to speed up towel drying.

- Press the [Prog] button until the display shows the "2h-Timer" icon.

The device is activated at the maximum power for 2 hours, up to a maximum room temperature of 32°C. The "Timer-2h" mode is automatically deactivated after a period of 2 hours and the device returns to the operative mode previously set. The user can switch to another operative mode at any time by simply pressing the [PROG] button.

## PILOT WIRE MODE

(Only for product versions equipped with "Pilot Wire")

In "Pilot Wire" mode, the device is managed by a central control system that sets the operating mode for all the connected devices. The device operates with the most advanced "Pilot Wire" system with six commands, which allows the following functions:

- 1 Standby: Power off the heating element, the device remains active.
- 2 Comfort: Maintains the "Comfort" temperature set by the user.
- 3 Eco: Maintains the room temperature 3,5°C below the "Comfort" temperature.
- 4 Frost Protection: Maintains the room temperature at 7°C.
- 5 Eco-1: Maintains the room temperature 1°C below the "Comfort" temperature.
- 6 Eco-2: Maintains the room temperature 2°C below the "Comfort" temperature.

The user can set the desired temperature on the device.

- Press the [Prog] button until the display shows the "Pilot Wire" icon.
- Set the desired temperature trough [+] and [-] buttons and wait until the displayed temperature stops blinking.

## CHRONO MODE

This operating mode allows the user to configure different temperature values for each hour of each day of the week. The "Comfort" / "Eco" temperatures and the related time intervals can be programmed. To activate this function:

- Press the [Prog] button until the display shows the "Chrono" icon.

### PROGRAMMING THE "CHRONO" MODE

#### a) Setting the day of the week and time

- Enter into "Stand-by" mode and press the [-] button at least 3 seconds.
- On the upper part of the display the message "Set" will be displayed.
- To set the day and time press the [+] button until the bottom part of the display the message "Ted" is displayed.
- Press the [Prog] button to enter the editing mode.
- The blinking arrow indicates the currently selected day, pressing the [+] / [-] buttons the desired day can then be set. Press again the [Prog] button to confirm the selected day.
- The procedure for entering the time starts and the display shows the current time.

**Hours:** Use the [+] and [-] buttons to set the correct hour and confirm the selected value pressing the [Prog] button.

**Minutes:** Same procedure as for the hours. Confirm the selected value by pressing the [Prog] button.

- At the end of the procedure, the thermostat returns into "Stand-by" mode.

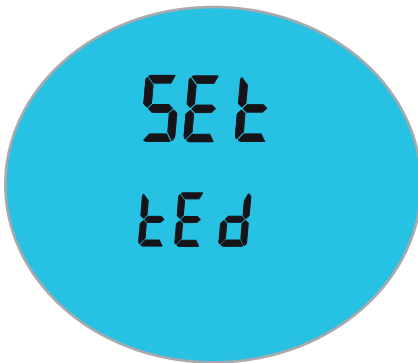

#### b) Setting the program for the "Chrono" mode.

- Enter into "Stand-by" mode and press the [-] button at least 3 seconds.
- On the upper part of the display the message "Set" will be displayed.
- To set the day and time press the [+] button until the bottom part of the display the message "Prog" is displayed.
- Press the [Prog] button to enter the editing mode.



- The procedure starts with day 1, and the desired sequence can be configured with the [+] and [-] buttons. For each hour of the day, it is possible to assign either the "Comfort" or "Eco" temperature.
  - o Press the [+] button to set the "Comfort" temperature level for the current hour. (full bar indication displayed).
  - o Press the [-] button to set the "Eco" temperature level for the current hour. (empty bar indication displayed).
- Press [Prog] to confirm the entered configuration for day 1, and repeat the same procedure for the remaining 6 days of the week.
- Press [Prog] button again when having finished the programme of the 7 days. The display returns into "Stand-by" mode.



**Note:** In case of loss of power supply, the settings of the "Chrono" mode remain stored in memory for a few minutes.



## KEY LOCK

It is possible to lock the buttons of the device to avoid inadvertent modifications of the settings.

Press the [Prog] button for 3 seconds to lock all the buttons except the [On/Off] button. The key-lock icon is activated on the display.

To unlock the buttons, press again the [Prog] button for 3 seconds.

The key-lock icon disappears on the display.



## OPEN WINDOW DETECTION FUNCTION

The "Open Window Detection" function enables detecting of an open window by sensing a sudden decrease of the temperature in the room. In such a case, the device deactivates the heating element for a maximum of 30 minutes or until an increase of the room temperature reveals that the window has been closed.

To activate this function:

- Enter into "Stand-by" mode.
- Press the [+] button for 3 seconds. The Open Window Detection icon is shown blinking in the display and its status.
- Press the [+] button to activate / deactivate the function.
- Press the [Prog] button to commit and return into "Stand-by" mode.

When this function is enabled, the "Open Window" icon on the display is lit and when the device detects that the window is opened, the "Open Window"

icon starts blinking. When the function is disabled the "Open Window" icon is not shown on the display.



**Note:** The device could fail in detecting an opened window e.g. if the thermostat is located on an isolated area of the room and far from air currents or if the thermostat is placed close to an external heating source.

## REMOTE CONTROL (OPTIONAL)

TBB-K towel rail is equipped with an IR receiver and therefore it can be remotely controlled through the optional remote-control device. All the functions previously described are available on the remote control.

## 4. MAINTENANCE

The towel rail doesn't require any type of special maintenance. Clean it with a cloth, only when the unit is disconnected and cold. Do not use solvents or abrasive products when cleaning.

The towel rail is filled with a precise quantity of special fluid. Any repairs that may require the opening of the towel rail must only be carried out by the manufacturer.

The towel rail has been manufactured to assured quality and according to processes to protect the environment. Once at the end of the useful life of the appliance, take it to a clean point so that its materials can be recycled appropriately.

## 5. WIRING DIAGRAM

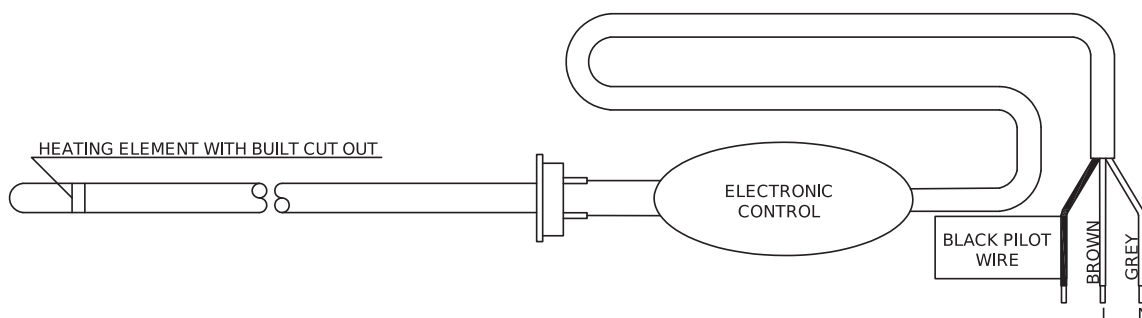

## 6. TECHNICAL SPECIFICATIONS

Model	TBB-8K	TBB-12K	TBC-8K	TBC-12K
Power (W)	300	600	300	500
Voltage (V)	220-240V-	220-240V-	220-240V-	220-240V-
Length (cm)	50	50	50	50
Width (cm)	8	8	8	8
Height (cm)	87	128	87	128
Weight (kg)	10	14	10	14
Isolation	Class II	Class II	Class II	Class II
IP Protection	IP44	IP44	IP44	IP44
Frequency (Hz)	50	50	50	50

## 7. PRODUCT FICHE

MODEL(S): GABARRON TBB-8K, TBB-12K

### ErP

Item	Symbol	Value				Unit
		TBB-8K	TBB-12K	TBC-8K	TBC-12K	
<b>Heat Output</b>						
Nominal heat output	$P_{nom}$	0.3	0.6	0.3	0.5	kW
Minimum heat output	$P_{min}$	N.A.	N.A.	N.A.	N.A.	kW
Maximum continuous heat output	$P_{max,c}$	0.3	0.6	0.3	0.5	kW
<b>Auxiliary electricity consumption</b>						
At nominal heat output	$eI_{max}$	0.000	0.000	0.000	0.000	kW
At minimum heat output	$eI_{min}$	0.000	0.000	0.000	0.000	kW
In standby mode	$eI_{sb}$	<0.0005	<0.0005	<0.0005	<0.0005	kW



El símbolo en el producto o en su embalaje indica que este producto no se puede tratar como desperdicios normales del hogar. Este producto se debe entregar al punto de recolección de equipos eléctricos y electrónicos para reciclaje. Al asegurarse de que este producto se deseché correctamente usted ayudará a evitar posibles consecuencias negativas para el ambiente y la salud pública, lo cual podría ocurrir si este producto no se manipula de forma adecuada. Para obtener información más detallada sobre el reciclaje de este producto, póngase en contacto con la administración de su ciudad, con su servicio de desechos del hogar o con la tienda donde compró el producto. Estas disposiciones solamente son válidas en los países miembros de la UE.

The symbol on the product or in its packaging indicates that this product may not be treated as household waste. Instead it shall be handed over to the applicable collection point for the recycling of electrical and electronic equipment. By ensuring this product is disposed of correctly, you will help prevent potential negative consequences for the environment and human health, which could otherwise be caused by inappropriate waste handling of this product. For more detailed information about recycling of this product, please contact your local council office, your household waste disposal service or the shop where you purchased the product. These instructions are only valid in the EU member states.

**Supplier:**

ELNUR UK Ltd.  
Unit 1, Brown Street North  
Leigh, Lancashire, WN7 1BU.  
+44(0)1942 670119  
info@elnur.co.uk

**Manufactured by:**

ELNUR S.A.  
Travesía de Villa Esther, 11 28110, Algete  
Madrid Telephone: +34 916281440

15190020 R2 | EN

[www.elnur.co.uk](http://www.elnur.co.uk)



© All rights reserved. As part of the continuous improvement policy, ELNUR, S.A. reserves the right to alter or modify any specifications without notice.