

Installation Instructions & User Guide

INGENIUM
WIFI Thermal Radiators

RD4W | RD6W | RD8W | RD10W | RD12W | RD14W



Please read these instructions carefully before installing or using this appliance for the first time.

ELNUR powered by
Gabarrón

1. IMPORTANT INFORMATION

- The warranty of the heater will not cover any damage caused by non-observance of any of these instructions.
- The instructions should be retained for future reference. This guide must be kept and given to any new owner.
- This appliance can be used by children aged from 8 years and above and persons with reduced physical, sensory or mental capabilities or lack of experience and knowledge if they have been given supervision or instruction concerning the use of the appliance in a safe way and understand the hazards involved. Children must not play with the appliance. Cleaning and user maintenance must not be made by children without supervision.
- Children aged from 3 years and less than 8 years shall only switch on/off the appliance provided that it has been placed or installed in its intended normal operating position and they have been given supervision or instruction concerning use of the appliance in a safe way and understand the hazards involved. Children aged from 3 years and less than 8 years shall not plug in, regulate and clean the appliance or perform user maintenance.
- Children of less than 3 years should be kept away unless continuously supervised.
- Please check that the voltage in the rating label fits the power supply.
- The use of these heaters is forbidden in any area where there is a presence of gases, explosives or inflammable objects.
- Do not use this heater to dry clothes. Do not cover this heater or put objects in contact with it.
- Neither the connecting cable nor any other object must come into contact with the hot unit.
- Do not cover this heater at any time.
- The air outlet at the top of the thermal radiator and the air inlet at the bottom are provided to ensure the most efficient operation of the appliance. They also protect the heater from overheating; therefore, it is essential that at no time are they covered.
- This heater should be switched off at the isolating switch before any repair work is carried out.
- The installation must be carried out in accordance with the current electrical regulations.
- Should the heater be moved and reinstalled it is essential that the work is carried out by a fully qualified technician.
- The heater should not be installed just below an electrical socket.
- The appliance must be installed in such a way that it is impossible for anyone using a bath or shower, to touch the controls.
- The heater is fitted with a flexible cable size 3 x 1.00 mm² for electrical connection. It may be used to connect the heater to the fixed wiring of the premises through a suitable connection box positioned adjacent to the heater.
- The supply circuit to the heater must incorporate a double pole isolating switch having a contact separation of at least 3 mm.
- If the flexible power cable for this unit is damaged, it may only be replaced by a repair workshop recognised by the manufacturer, as special tools are necessary.
- This appliance must be earthed.
- All models are supplied with an electrical interrupt cut-out. This will switch off the heater if, for any reason, it overheats. Should the cut-out operate, turn the heater off and remove the cause of the overheating. The cut-out will be reset automatically.
- This heater is filled with a precise quantity of special oil. Repairs requiring opening of the oil container are only to be made by the manufacturer or his service agent who should be contacted if there is an oil leakage.
- Regulations concerning the disposal of oil when scrapping the appliance have to be followed.
- The presence of air particles of smoke, dust and other pollutants could, in time, discolour the walls and surfaces around the heater.
- CAUTION – Some parts of this product can become very hot and cause burns. Particular attention must be given when children and vulnerable people are present.



CAUTION: Some parts of this product can become hot and cause burns. Particular attention must be given when children and vulnerable people are present.

2: INSTALLATION INSTRUCTIONS

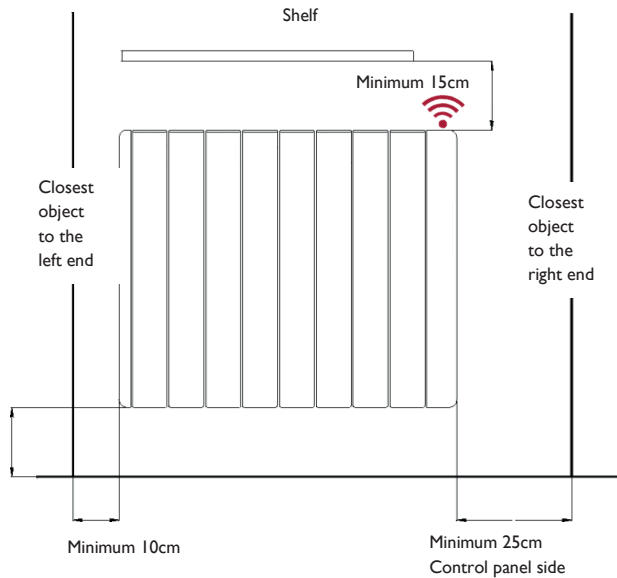

- Open the package and check that it is the correct model and it is in good condition.
- To obtain optimum performances it is necessary to maintain a minimum clearance of 15 cm between the radiator and any inflammable material as furniture, curtains etc.
- The rest of clearances required to maintain are indicated on the figure opposite:

Position and fix the brackets at the correct distance from the floor. It is possible to use the radiator as measuring unit by positioning it on two polystyrene package elements and placing two supports above as indicated on the figure:

- The studs and screws to attach the supports are in the accessories bag.
- Hang the unit on the hooks of the brackets.
- By turning the screws, the metallic square will go downwards, retaining the heater. Repeat this on the other bracket.

Mark the fixing points on the wall using a pencil through the two fixing holes in the square brackets and perform corresponding bores.

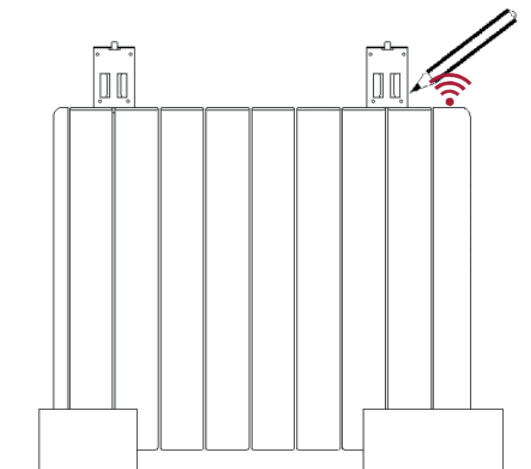

3: USING THE THERMAL RADIATOR

Main switch.
All models are equipped with one switch on the back surface allowing the heater disconnection.

Daily Programming
Temperature level for each time interval (1h) of the day.

Temperature setpoint

Operating mode

G-CONTROL

Link A

G-Control Hub
Connection indicator.

Heating on indicator.

Current set point temperature in AUTO mode.

OK / Mode Button
Press the button to select operation mode: Auto, Manual, Off, and to set the value of the different parameters.

Config / Prog Button
Press the button to programme and configure the thermal radiator in AUTO Mode.

Backlight

Pressing any button the display will illuminate with a soft white colour. After certain time if no buttons are pressed the display backlight will turn off.

Operating Modes

Press **OK**, the operation modes are displayed, with the selected one flashing. Use **+** or **-** to select the desired operation mode. Confirm with **OK**.

The heater has three different operation modes: **Auto**, **Manual override** and **OFF**.

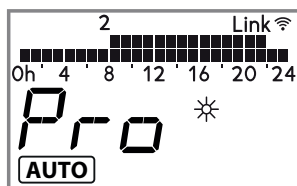

3.1. On/Off

Once the heater is connected to a main supply you can turn the heater ON by switching the main ON/OFF switch positioned at the rear right side of the heater as shown above.

3.2. Setting The Time

We start by first setting the Day and Time.

3.2.1 You can do this by Press & Holding the **Config/Prog.** button until the following is shown. Press & Release the **Config/Prog** button 7 times again to advance through the 7th days programming.

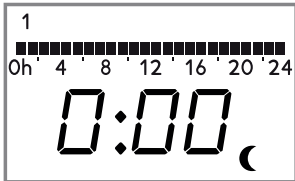

3.2.2. When pressing **Config/Prog** button when the 7th day programming is displayed, you enter in the Time Setting. The day of the week starts to flash. Using the "+" and "-" buttons select today's date. 1=Monday, 2=Tuesday, Etc. and Press the OK/Mode button.



3.2.3. Now the hours start to flash. Press the "+" and "-" button until you reach the correct time (hour) and Press the **OK/Mode** button.



3.2.4. Now the minutes start to flash. Press the "+" and "-" button until you reach the correct time (minutes) and Press the **OK/Mode** button.

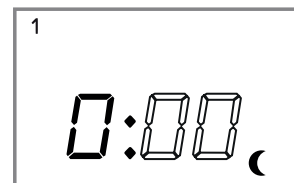

If the device is associated with a G-Control Hub, the adjustment of time is removed and the time in the G-Control Hub is configured in the heater automatically.

3.3. Programming

Select Auto Mode. Within this mode, the setpoint temperature varies according to the weekly schedule setup in the unit. Default programming is: **Comfort:** 07:00 to 22:00 / **Eco:** 00:00 to 07:00 & 22:00 to 00:00.

3.3.1 Press & Hold the **Config/Prog.** button until the following is shown. The first segment will start to flash. By pressing the **OK/Mode** button you can select whether you want a Frost setting ❄️ (5°C), Background setting 🌙 (17°C) or Comfort setting ☀️ (19°C). Now press the "+" button to move to the next 1 hour time interval.

Note: These temperatures can be changed later without adjusting the times.

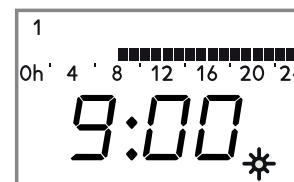
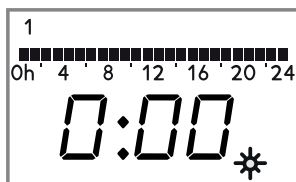

3.3.2 Once you've gone through all the time intervals for day 1, you will automatically start on day 2. Repeat the above steps until you go through all 7 days. If you do not desire to modify the programming of a specific day, use the **Config/Prog** button to advance to the next day programming. Once you have configured the desired programming, press **Config/Prog** button to exit programming.

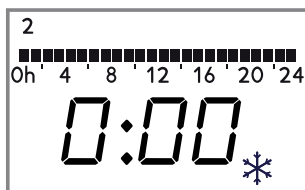

3.3.3 After going through all the days, the display will show and start to run the program and will flash between the set temperature for the current day, time interval and the word **Pro** to indicate the heater is running the set program.

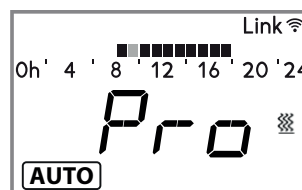
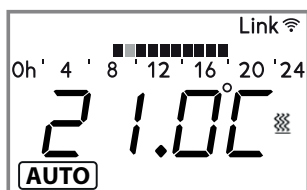

3.4. Temperature Levels



In the AUTO mode, you can temporarily change the set temperature for the time period. You can increase or decrease this temperature simply by pressing the "+" or "-" buttons. Once the time period finishes, the temperature will revert back to the programmed set temperature.

You can modify the set temperatures within the program permanently too, to do this, Press & Release the **Config/Prog** button until the display shows the flashing temperature symbol

Now press the **OK/Mode** button to select the temperature 

you want to change, COMFORT or ECONOMIC, and use the "+" or "-" button to select the desired temperature.





-  **COMFORT:** Recommended for the periods of time when the user is at home and the maximum comfort is required. Default value 19°C.
-  **ECONOMIC:** Recommended for nights and small away periods of time. Default value 17°C.
-  **FROST PROTECTION:** Recommended for long away periods of time. Default value 5°C.

It is possible to exit of temperature level configuration by pressing the **Config/Prog** button at any time.

3.5. Manual Override

In manual mode, the heater will maintain the temperature set point and will ignore the pre-set program. By default, the initial temperature set point is 19°C.

3.5.1 To modify the temperature set point, Press the "+" or "-" button until the desired temperature is shown. The heater will now cycle on and off and maintain this temperature setting. If the room temperature goes below the set temperature, then the heaters element will turn on and the symbol  will be shown. If the room temperature is higher than the set temperature, then the heaters element won't turn on and the heating symbol  won't be displayed.



3.6. Off Mode

It is possible to put the heater in standby mode where the heater doesn't maintain any set temperature or run any programs, keeping the time settings configured previously. When in this mode, the heater will display the current time and the word **OFF**.

3.6.1 To select the OFF mode, Press **OK**, operation modes are displayed, with the selected one flashing. Use **+** or **-** to select **OFF** mode. Confirm with **OK**.



3.6.2 If the heater is turned off via the main switch at the back of the heater or if the power to the heater is removed and the heater is not connected to a Wifi G-Control Hub then the time setting within the heater will be lost.

3.7. Open Window Detection

With open window detection activated, the heating element will be disconnected automatically when a sharp decrease in temperature in the room is detected avoiding energy wastage. After this period of time, the radiator returns to the prior operation mode.

It will be shown in the displays as follows:



Note: To activate the window detection please refer to C5 in 3.10. ADVANCED CONFIGURATION section.

3.8. Adaptive Start Control

Ingenium electronic control analyses the heating requirements of the room where the radiator is installed using this information to turn on the heating element in advance in order to reach the set point temperature at the desired time.

It will be shown in the displays as follows:



Note: To activate the adaptive start control please refer to C6 in 3.10. ADVANCED CONFIGURATION section.

3.9. Keyboard Lock

In every operation mode, it is possible to lock the keyboard by holding "+" and "-" buttons simultaneously for 3 seconds. When the keyboard is locked, the message Lock will be displayed.

When the keyboard is locked, if any button is pressed, the display will show "Lock" and the unit will not respond.



To unlock the keyboard, press the "+" and "-" buttons simultaneously for 3 seconds.

3.10. Advanced Configuration

3.10.1 To access to advanced configuration menu, Press & Release Config/Prog button until the following is displayed:



3.10.2 Hold the Config/Prog button for 5 seconds, the first parameter (C1) will be displayed. To select the next parameter, press the "+" button.



To modify the value of the parameters, press the OK/ Mode button. Then use the "+" and "-" buttons to select the different options. Press the Ok/Mode button again to set the value.

Use the same procedure to modify the others parameters where necessary. It is possible to exit of advanced configuration by pressing the Config/Prog button at any time.

Parameters

- **C1.** Fahrenheit or Celsius Degrees.
The LCD displays the temperature unit selected: °C or °F.
- **C2.** Control Adjustment.
The kind of temperature control can be modified with this parameter:
 - PID, Hysteresis 0,25°C, Hysteresis 0,35°C, Hysteresis 0,50°C, Hysteresis 0,75°C.
- **C3.** Correction of ambient temperature measures.
If there is a difference between an external thermometer and the temperature displayed by the unit, with C3 parameter it is possible to influence on the sensor in order to balance the difference. (-3°C to +3°C in 0,1 steps).
- **C4.** Firmware version.
Information about the current firmware version of the unit.
- **C5.** Open Window Activation
ON/OFF. With the parameter in ON, the open window detection is activated.
- **C6.** Adaptive Start Control
ON/OFF. With the parameter in ON, the adaptive start control is activated.

4. Remote Operation using the Wifi G-Control Hub

It is possible to control the full operation of the unit remotely with Elnur Gabarron App or Web-App. The unit must be connected to a Wifi G-Control Hub connected to the internet to use this feature.

4.1 To associate the unit to the G-Control Hub, the discovery mode of the hub must be activated. Press the associate button at the back of the Gateway for 3 seconds. An orange blinking light every second indicates association mode.



4.2 With the hub in discovery mode, press the Ok/Mode button on the heater for 3 seconds until the Link symbol is shown.

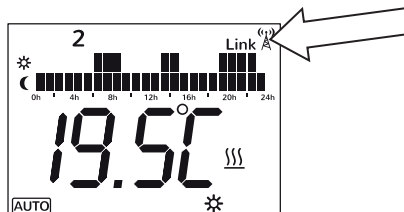

You can now control and adjust the programming and temperatures on the heater via the Elnur Gabarron app.

4.3 To disassociate the unit, a reset of the unit must be completed. See "5. UNIT RESET". When the heater is reset, it will remove the programming and revert back to the default settings and also disassociate from the RF network and G-Control Hub.

5. Unit Reset

The heater reset removes the programming and disassociates the device from the RF network if the unit was associated with a G-Control Hub. Default values are established. To reset the unit, hold the OK/Mode and Config/Prog buttons simultaneously for 10 seconds, the display will show the following to indicate the heater has been reset.

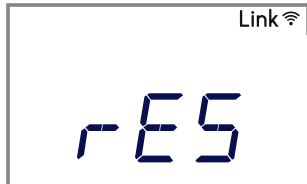

To confirm the reset of the unit, press **OK/Mode** button, to cancel it any other button can be pressed.

6. DEFAULT VALUES

Operation mode	OFF
Comfort temperature	19°C
Economic temperature	17°C
Frost protection temperature	5°C
Ambient sensor Offset	0°C
RF associated	No
Temperature Unit	°C
Open Window detection	Disabled
Adaptive Start Control	Disabled
Control mode	PID
Default Programming in AUTO Mode	Comfort: 07:00 to 22:00. Eco: 00:00 to 07:00 & 22:00 to 00:00.

7. CLEANING AND MAINTENANCE

The radiators do not need any special maintenance. Clean dust with a dry, soft cloth only when the unit is disconnected and cold.

Do not use solvents or abrasive products for cleaning.

After the heating season disconnect the radiator with the switch located on the back surface of the radiator.

This thermal radiator has been manufactured under an assured quality system using environment friendly processes.

Please take the heaters to a clean point once their useful life is finished, in order to recycle their materials in the right way.

8. TROUBLESHOOTING

The radiator does not heat Check the heater or the air inlets are not covered.

The room does not reach the required temperature Check the selected temperature is in accordance with the desired temperature. Maybe the room needs more heating power.

"OC", "SC" message is displayed Sensor wrong connection. Contact the after sales service.

"Err1", "Err2", "Err3", "Err4" message is displayed Contact the after sales service.

Time settings are lost There was electric supply shortage or the unit has been disconnected by the main switch.

Keyboard does not respond If the Lock message is displayed, the thermal radiator keyboard is locked. Hold "+" and "-" buttons simultaneously for 3 seconds to unlock the keyboard.

The radiator does not communicate with the G Control Hub Check the unit is associated, the symbol must be shown on the display LCD. For distances greater than 30 metros and 2-3 walls, associate first the closest unit because of each unit can work as repeater. If symbol is blinking, check the G Control Hub connection to the network, and if any other device in the RF Net that could be working as repeater has been removed.

9. SPECIFICATIONS

Models	RD4W Plus	RD6W Plus	RD8W Plus	RD10W Plus	RD12W Plus	RD14W Plus
Elements	4	6	8	10	12	14
Length (cm)	42	58	74	90	106	122
Width (cm)	8 cm plus 2 cm clearance					
Height (cm)	58					
Weight (kg)	9	12	15	18	21	24.5
Voltage	220 - 240 -					
Isolation	Class I					
Power (W)	500	750	1000	1250	1500	2000
Electronic Control	Triac	Triac	Triac	Triac	Triac	Relay
All models are equipped with control function through G-Control Hub connected to the network.						

10. MAIN COMPONENTS LIST

Right side plastic case	ref. 46102362	500 W Heating Element	ref. 30100142
Left side plastic case	ref. 46102364	750 W Heating Element	ref. 30100152
Electronic Control PCB (Except RD14W model)	ref. 46102300	1000 W Heating Element	ref. 30100162
Electronic Control PCB (Only RD14W model)	ref. 46102310	1250 W Heating Element	ref. 30100172
Main switch	ref. 46100530	1500 W Heating Element	ref. 30100182
Temperature sensor	ref. 46102195	2000 W Heating Element	ref. 30100202
85°C thermal limiter	ref. 30100040		

11. WIRING

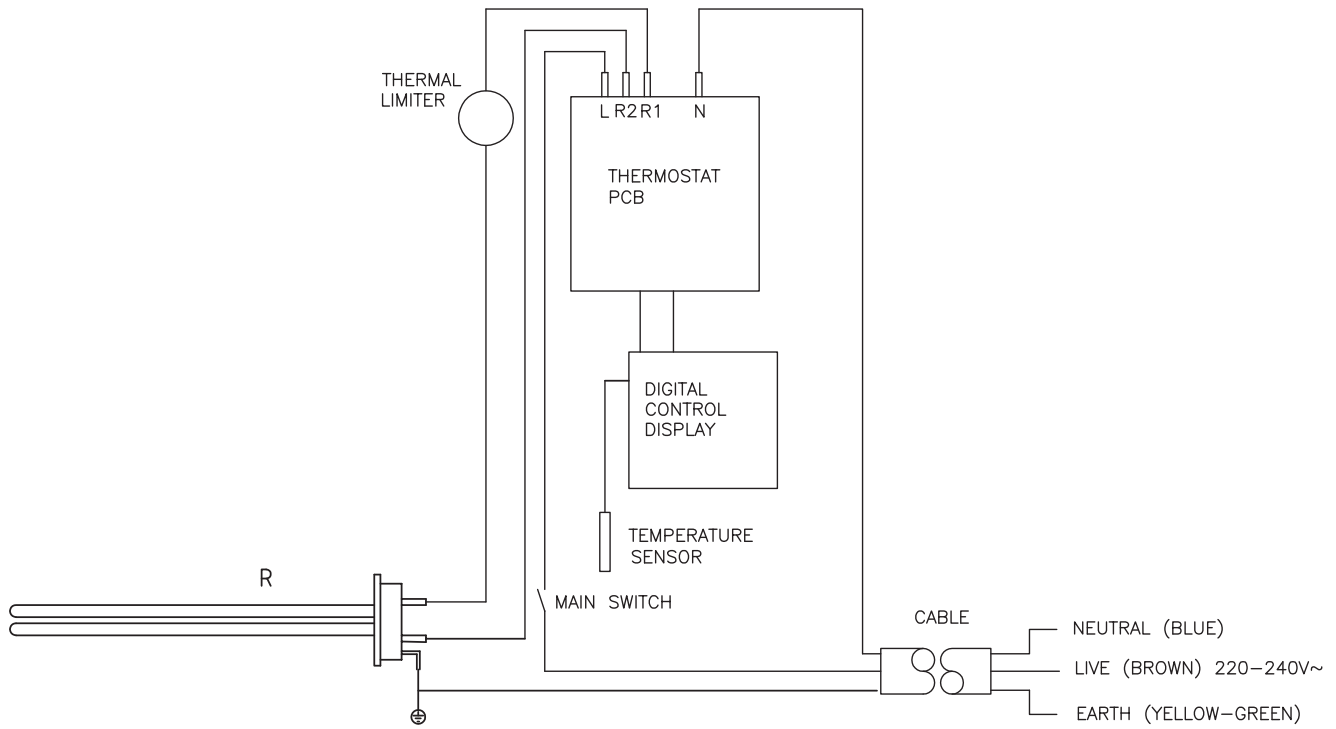

PRODUCT FICHE

MODEL(S): GABARRON RD4W, RD6W, RD8W, RD10W, RD12W, RD14W

ErP

Item	Symbol	Value						Unit
		RD4W PLUS	RD6W PLUS	RD8W PLUS	RD10W PLUS	RD12W PLUS	RD14W PLUS	
Heat Output								
Nominal heat output	P _{nom}	0.5	0.75	1.0	1.25	1.5	2.0	kW
Minimum heat output	P _{min}	N.A.	N.A.	N.A.	N.A.	N.A.	N.A.	kW
Maximum continuous heat output	P _{max, c}	0.5	0.75	1.0	1.25	1.5	2.0	kW
Auxiliary electricity consumption								
At nominal heat output	el _{max}	0.000	0.000	0.000	0.000	0.000	0.000	kW
At minimum heat output	el _{min}	0.000	0.000	0.000	0.000	0.000	0.000	kW
In standby mode	el _{sb}	<0.0005	<0.0005	<0.0005	<0.0005	<0.0005	<0.0005	kW

Item	Value. All models
Type of heat output / room temperature control	
Electronic room temperature control plus week timer	Yes
Other control options	
Room temperature control, with open window detection	Yes
With distance control option	No
With adaptive start control	Yes

Contact details	ELNUR, UK Unit 1, Brown Street North, Leigh, Lancashire, WN7 1BU
------------------------	---

Commission Regulation (UE) 2015/1188 of 28 April 2015. Ecodesign requirements for electric storage local space heaters.



El símbolo en el producto o en su embalaje indica que este producto no se puede tratar como desperdicios normales del hogar. Este producto se debe entregar al punto de recolección de equipos eléctricos y electrónicos para reciclaje. Al asegurarse de que este producto se deseché correctamente usted ayudará a evitar posibles consecuencias negativas para el ambiente y la salud pública, lo cual podría ocurrir si este producto no se manipula de forma adecuada. Para obtener información más detallada sobre el reciclaje de este producto, póngase en contacto con la administración de su ciudad, con su servicio de desechos del hogar o con la tienda donde compró el producto. Estas disposiciones solamente son válidas en los países miembros de la UE.

The symbol on the product or in its packaging indicates that this product may not be treated as household waste. Instead it shall be handed over to the applicable collection point for the recycling of electrical and electronic equipment. By ensuring this product is disposed of correctly, you will help prevent potential negative consequences for the environment and human health, which could otherwise be caused by inappropriate waste handling of this product. For more detailed information about recycling of this product, please contact your local council office, your household waste disposal service or the shop where you purchased the product. These instructions are only valid in the EU member states.

Supplier:

ELNUR UK Ltd.
Unit 1, Brown Street North
Leigh, Lancashire, WN7 1BU.
+44(0)1942 670119
info@elnur.co.uk

Manufactured by:

ELNUR S.A.
Travesía de Villa Esther, 11 28110, Algete
Madrid Telephone: +34 916281440

15190020 R2 | EN

www.elnur.co.uk



© All rights reserved. As part of the continuous improvement policy, ELNUR, S.A. reserves the right to alter or modify any specifications without notice.